

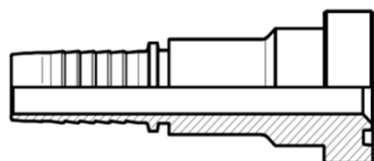

EC..PHC

FLANGE

CATERPILLAR FLENSAANSLUITING
EMBOUT À BRIDE CATERPILLAR
CATERPILLAR FLANGE



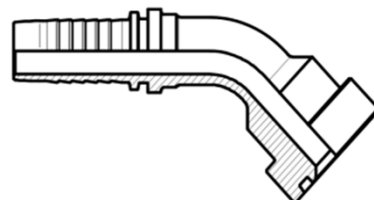

Referentie Référence Reference				Flange / Diameter	 BAR
	DN	MM	INCH		
EC1212PHC	20	19,0	3/4"	3/4" / 41.3mm	350
EC1216PHC	20	19,0	3/4"	1" / 47.6mm	350
EC1616PHC	25	25,4	1"	1" / 47.6mm	280
EC1620PHC	25	25,4	1"	1 1/4" / 54mm	280
EC2020PHC	32	31,8	1 1/4"	1 1/4" / 54mm	210
EC2024PHC	32	31,8	1 1/4"	1 1/2" / 63.5mm	210
EC2424PHC	38	38,1	1 1/2"	1 1/2" / 63.5mm	185



EC..PHC45

FLANGE

CATERPILLAR FLENSAANSLUITING 45°
EMBOUT À BRIDE CATERPILLAR 45°
CATERPILLAR FLANGE 45°

Referentie Référence Reference				Flange / Diameter	 BAR
	DN	MM	INCH		
EC1212PHC45	20	19,0	3/4"	3/4" / 41.3mm	350
EC1216PHC45	20	19,0	3/4"	1" / 47.6mm	350
EC1616PHC45	25	25,4	1"	1" / 47.6mm	280
EC1620PHC45	25	25,4	1"	1 1/4" / 54mm	280
EC2020PHC45	32	31,8	1 1/4"	1 1/4" / 54mm	210
EC2024PHC45	32	31,8	1 1/4"	1 1/2" / 63.5mm	210
EC2424PHC45	38	38,1	1 1/2"	1 1/2" / 63.5mm	185

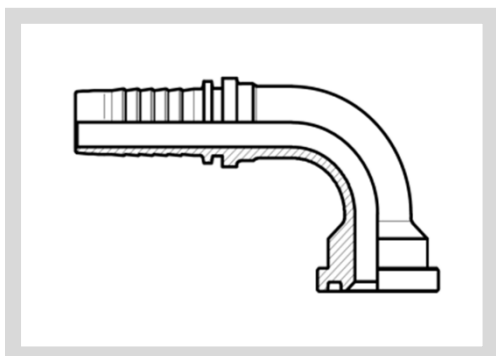



EC..PHC90

FLANGE

CATERPILLAR FLENSAANSLUITING 90°

EMBOUT À BRIDE CATERPILLAR 90°

CATERPILLAR FLANGE 90°

Referentie Référence Reference					
	DN	MM	INCH		Flange / Diameter
EC1212PHC90	20	19,0	3/4"	3/4" / 41.3mm	350
EC1216PHC90	20	19,0	3/4"	1" / 47.6mm	350
EC1616PHC90	25	25,4	1"	1" / 47.6mm	280
EC1620PHC90	25	25,4	1"	1 1/4" / 54mm	280
EC2020PHC90	32	31,8	1 1/4"	1 1/4" / 54mm	210
EC2024PHC90	32	31,8	1 1/4"	1 1/2" / 63.5mm	210
EC2424PHC90	38	38,1	1 1/2"	1 1/2" / 63.5mm	185

Opmerking: de hoogte van de Caterpillarflens bedraagt 14,3mm

Remarque: la hauteur du bride Caterpillar est 14,3mm

Remark: the hight of the Caterpillar flange is 14,3mm